

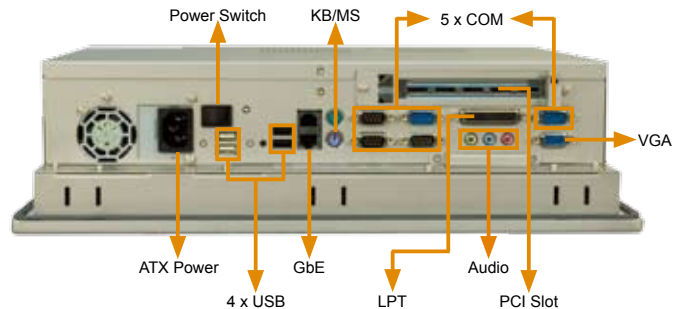



PPC-5150GS *Pentium® 4 / Celeron® D Panel PC with 15" TFT LCD and Touchscreen*



Features

1. Most popular panel PC form factor
2. High performance Intel® Pentium® 4 / Celeron® CPU support
3. DDR memory DIMM support up to 2GB
4. Pentium® 4/ Celeron® D industrial main board
5. Easy installing and mechanism design
6. High brightness 15" industrial grade panel
7. IP 65 compliant aluminum die-casting front panel

Specifications

Model	 PPC-5150GS	 PPC-5150A-9455 
CPU	Socket 478 Intel® Pentium® 4 or Celeron® D with a 533 MHz (max.) FSB	LGA 775 Intel® Core™2 Duo, Pentium® D, Pentium® 4 or Celeron® D with a 1066/667/800/533 MHz FSB
Chipset	Intel® 852GME + ICH5	Intel® 945G + ICH7
Memory	2 x 2 GB (max.) 333/266 MHz DDR DIMM	2 x 2 GB (max.) DDR2 DIMM (system max. 4 GB)
VGA	Intel® 852GME supports dual display	Intel® 945G supports dual display
SSD	CF Type II	CF Type II
Drive Bay	1 x 2.5" SATA/IDE HDD bay with anti-shock (or two 2.5" SATA/IDE HDD bays without anti-shock) 1 x Slim Type CD-ROM bay 1 x Slim Type FDD bay	1 x 2.5" SATA HDD bays with anti-shock 1 x Slim Type CD-ROM bay
Ethernet	2 x Realtek RTL8110S Gigabit Ethernet controller	2 x Broadcom BCM5787M PCIe GbE chipsets with ASF2.0 remote control support
Audio	AC '97 2.3 Realtek ALC655	HD Audio Realtek ALC883
I/O	- 1 x RS-232/422/485 - 4 x RS-232 - 6 x USB 2.0 - 2 x PS/2 (KB/MS) - 1 x LPT - 1 x VGA out - 2 x LAN - 3 x Audio (Lin-in, Line-out, MIC-in) - 2 x IDE - 2 x SATA	- 4 x RS-232 - 1 x RS-232/422/485 - 1 x VGA - 1 x Print - 2 x LAN - 4 x USB - 3 x Audio (Line-in, Line-out, Mic-in)
Expansion Slot	1 x PCI slot	1 x PCI slot, 1 x PCIe mini Card
Touch Screen	5-wire resistive type with RS-232 interface	5-wire resistive type with RS-232 interface
LCD	- Resolution :1024x768 (XGA) - Brightness : 350 cd/m ² - Contrast Ratio : 700:1 - Viewing Angle (H-V):140/125 - Backlight MTBF : 50000hrs	- Resolution :1024x768 (XGA) - Brightness : 350 cd/m ² - Contrast Ratio : 700:1 - Viewing Angle (H-V):140/125 - Backlight MTBF : 50000hrs
Operating Temperature	0 °C ~ 50°C.	
Storage Temperature	-20°C ~ 60°C.	
Vibration	-5~17Hz 0.1" double amplitude displacement, 17~640 Hz 1.5G acceleration peak to peak	
Shock	10G acceleration peak to peak. (11 ms)	
Relative Humidity	5%~ 95% @ 60°C, non-condensing	
Net / Gross Weight	7 Kg / 11 Kg	
Dimensions (W x H x D)	452 mm x 356 mm x 11 0 mm	
Power Supply	ATX Power - 180W, ACE-4518AP-RS - Input: 90 ~ 240VAC @ 50/60Hz - Output (max.): 3.3V@16.8A, 5V@12A, 12V@10A, - 12V@0.8A	ATX Power - 180W, ACE-4518AP-RS - Input: 90 ~ 240VAC @ 50/60Hz - Output (max.): 3.3V@16.8A, 5V@12A, 12V@10A, - 12V@0.8A
Front Panel Protection	IP 65 compliant	
Certificate	Meets CE, FCC	

Dimensions (Unit: mm)

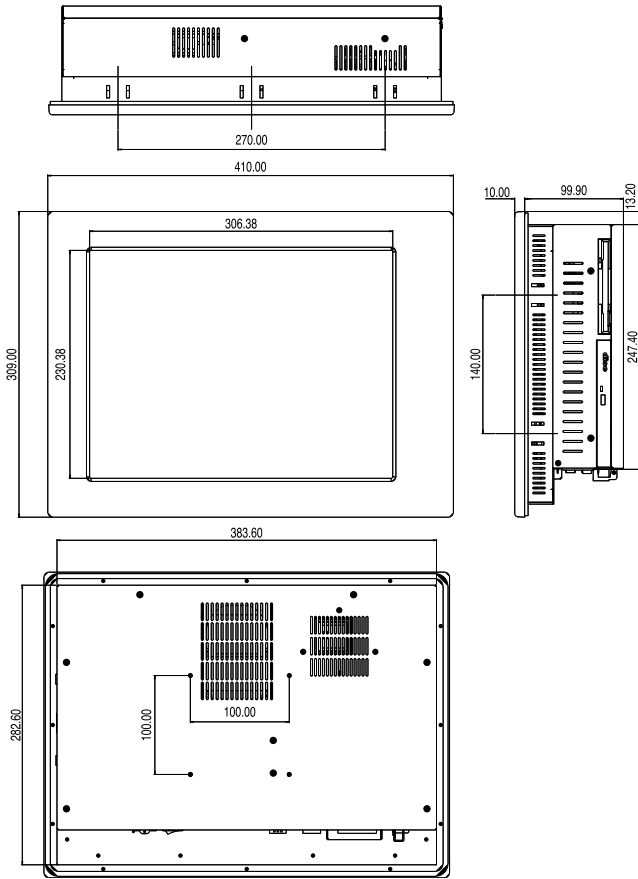

Packing List

Part Number	Description	Amount
32000-000002-RS	Power Cord	1
19100-000037-RS	CPU Cooler	1
19B00-000013-RS	CD-ROM Installation Kit	1
WK-150MS-R10	Wall Mounting Kit	1
PK-150M	Panel Mounting Kit	1
32200-014506-RS	HDD IDE Cable (44-pin + 2 x 40-pin)	1
32200-019201-RS	HDD IDE Cable (44-pin + 40-pin)	1
32000-077000-RS	HDD SATA Cable	1
19B00-000013-RS	FDD Installation Kit	1
41011-0397C0-00-RS	HDD Bracket	1
33100-000079-RS	Jumper Pack	1
19600-000078-RS	Screw Kit	1
	User Manual & Driver CD	1
	Touch Screen Driver CD / Touch Pen (for T-R model only)	1

Ordering Information

PPC-5150GS/8520-P4-28G/4518AP/T-R/1GB	15" 350 cd/m ² XGA TFT Panel PC with POS-8520, 2.8 GHz Intel® Pentium® 4 CPU, 1GB RAM, ACE-4518AP and touch screen Silver color, RoHS
PPC-5150GS/8520-P4-28G/4520C/T-R/1GB	15" 350 cd/m ² XGA TFT Panel PC with POS-8520, 2.8 GHz Intel® Pentium® 4 CPU, 1GB RAM, ACE-4520C and touch screen Silver color, RoHS
Core™2 Duo	
PPC-5150A/9455-PIV651/4518AP/T-R/1GB	15" 350 cd/m ² XGA TFT Panel PC with POS-9455, CPU Pentium® 4, 3.4Ghz, Cool Gray color, PSU ACE-4518AP and Touch screen, w/ 1GB DDR2 RAM, RoHS
PPC-5150A/9455-PIV651/4520C/T-R/1GB	15" 350 cd/m ² XGA TFT Panel PC with POS-9455, CPU Pentium® 4, 3.4Ghz, Cool Gray color, PSU ACE-4520C and Touch screen, w/ 1GB DDR2 RAM, RoHS

Anti-Shock Protection

Anti-shock design enhances protection performance of hard drives dramatically in terms of shock and vibration tests.

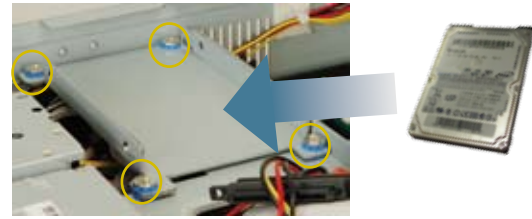

Shock Test

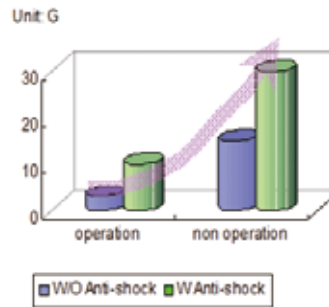

Vibration Test

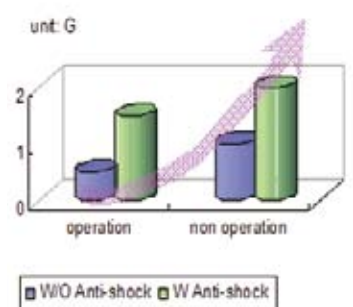

IQ Mount Supporting List

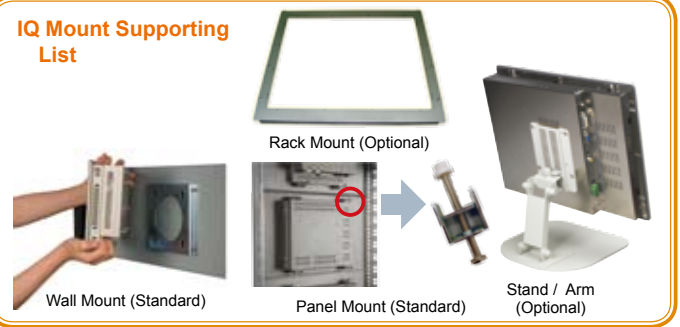

Power Supply Options

Type	Model No.	Watt	Remark
ATX AC-input	ACE-4518AP-RS	180W	
ATX DC-input	ACE-4520C-RS	200W	24VDC input

Options

RK-150MS-R10	Rack Mount kit
ARM-31-RS	LCD Monitor Arm
STAND-100-RS/STAND-210-RS	LCD Monitor Stand